

Swish.

SUPERLUXE

LENGTHS 300cm - 500cm MAXIMUM CURTAIN WEIGHT 14kg (30lbs)
Read all instructions carefully before installation.

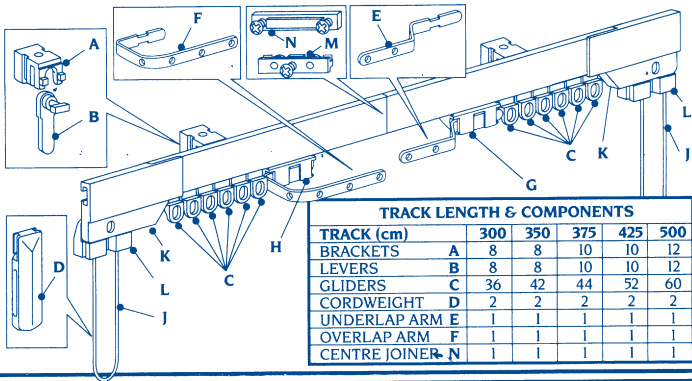

IMPORTANT INFORMATION FOR BAY WINDOWS
Please note that Superluxe track is only suitable for internal bends with a radius of 10" or more. With the front of the track facing you, bend the ends towards yourself.



1 BRACKET SPACING

We provide everything you need to fit this track to a wooden batten, pre-installed to a wall or ceiling, in straight runs or around bay windows. If fixing to plaster/masonry, wall plugs will be needed.

- Mark a straight level line along the batten to the finished track length required.
- Mark the end bracket positions 2cm (3/4") from each end of the line.
- Mark equally spaced positions for all remaining brackets.

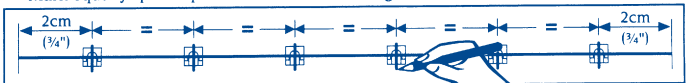

2 BRACKET FIXING

- Screw all brackets A into place. Push lever B into every bracket and leave pointing downwards.

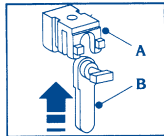
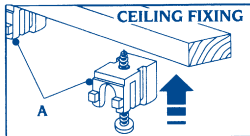
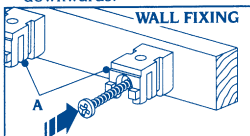

NOTE: FOR BAY WINDOWS BRACKET SPACING AROUND THE BEND IS INDICATED BELOW:

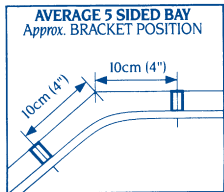
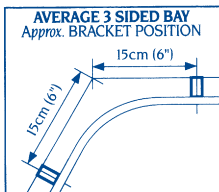
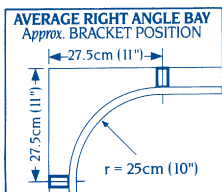

3A SHORTENING TRACK

SHORTENING TRACK FOR STRAIGHT WINDOWS

NOTE: If shortening a joined length of Superluxe, remove equal amounts of track from each end to ensure the join remains in the centre of the track, eg - to remove a total 10cm (4"), remove a length of 5cm (2") from one end of each track.

- Measure required track length noting that pulley housings K fit onto each end bracket.
- Pull both cords J to move master carriers G and H with gliders C to the track ends (open position).
- Unscrew centre joiner N and pulley wheel block M and move away from cutting area together with cords. Take care not to twist the cords.
- Carefully cut square using a hacksaw. Smooth cut edges.
- Replace pulley wheel block M and centre joiner N taking care not to twist cords.
- Tighten locking screws. Go to section 6.

