

Decorative Curtain Poles





Hand Operated Curtain Pole System

Silent Gliss® 6140M Metropole 50mm

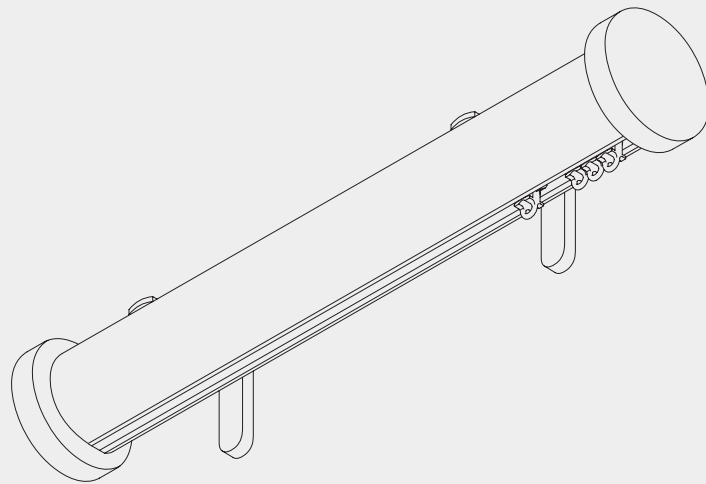

Product Information

- Hand operated system for domestic and contract applications.
- Can be bent for bay windows.
- Choice of 7 different finishes - black, white, steel grey, diva gold, silver and wood effects; mahogany and oak.
- Accessorised with matching end caps and co-ordinated or matching brackets/bracket covers.
- A selection of finials are available.
- Easy fitting to wall with adjustable brackets.
- For medium to heavy curtains.
- Suitable for use with Wave Standard and Wave XL curtain heading system.
- Profile length 6m (wood effect 5m).



6140M

Profile and Bending Information

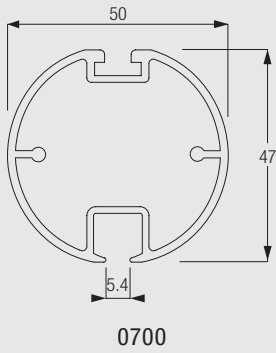

Note: It is important to observe the minimum bending radius for Wave XL. The system will not function with a smaller radius.

Specification Guide - download www.silentgliss.co.uk (password required)

Silent Gliss 6140M curtain track, hand drawn, aluminium, assembled complete with gliders 6143 at 10/m and 2 endcovers 0714. Face fix with bracket 0537 each screwed to timber /plugged and screwed to block-work/concrete at 600mm centres. Finished in black, white, steel grey, diva gold, silver and wood effects honey maple or mahogany.

How To Measure

Stack size calculation Wave XL

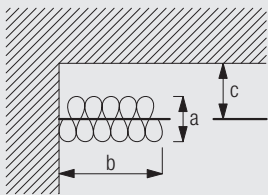

a = Stack depth 35cm
b = Stack size
c = Min. distance 22cm

System width		77-107	108-143	144-179	180-215	216-251	252-287	288-323	324-359	360-395
	b	21	26	31	36	41	46	51	56	61
System width		396-431	432-468	469-503	504-539	540-575	576-600			
	b	66	71	76	81	86	91			
System width		154-217	218-289	290-361	362-433	434-505	506-577	578-600		
	b	21	26	31	36	41	46	51		

(dimensions in cm)



6140M

Design Options

Finials

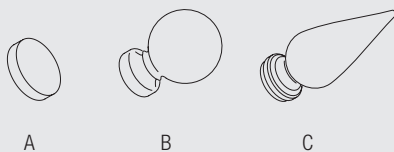

Finials are decorative elements that fit on at the end of the pole.

A: Without finials, endcaps 0714 matching the colour of the pole will be applied.

B: 0717 Ball End finial 125mm (available in all 0700 pole finishes).

C: 0718 Spear finial 150mm (available in all 0700 pole finishes).

All finials are made of real wood.

Wave Standard curtain heading system

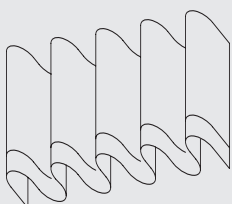

Wave is an exciting new contemporary curtain heading system which allows curtains to hang in a continuous wave which is smooth, simple and elegant.

When using the Wave curtain heading system please note the maximum recommended curtain weight is 2.5kg/m.

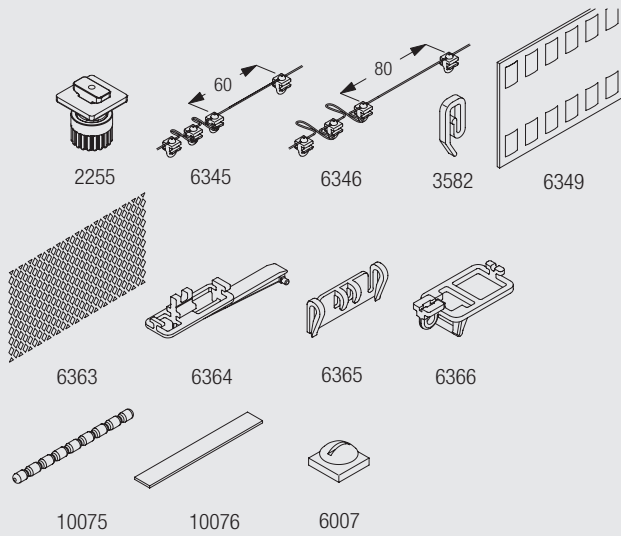

The Wave standard components are:

- 2255 Adjustable brake
- 6345 Glider Cord 60mm
- 6346 Glider Cord 80mm
- 3582 Hook
- 6349 Curtain tape
- 6363 Iron-on top hemming tape
- 6007 End stop

Additional optional Wave components:

- 6364 Extension (for use with 6365)
- 6365 Hanger (for use with 6364)
- 6366 Carrier for draw rod
- 10075 Lead weight for bottom hem 50gr/m
- 10076 Fabric weight for side of curtain

Wave XL curtain heading system

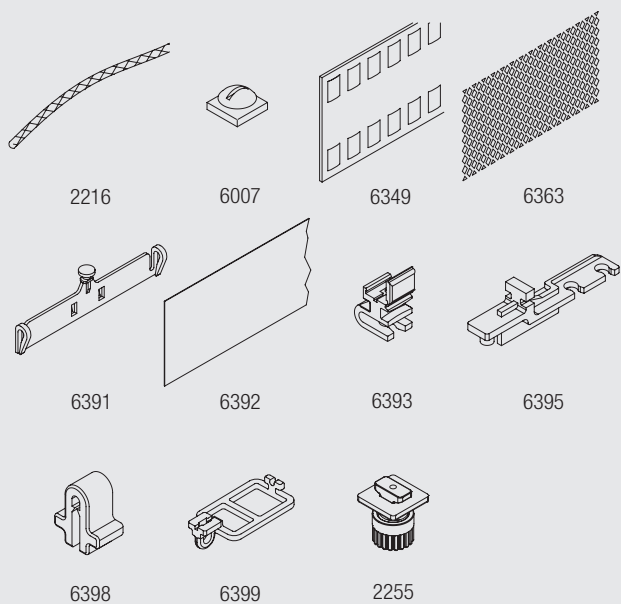
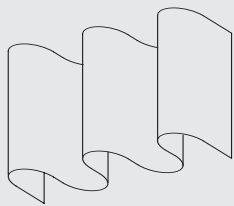

Wave XL is especially designed for high and large application areas through generously designed waves with large cross section dimensions.

The Wave XL components are:

- 2216 Cord 0.85 mm
- 2255 Adjustable brake
- 6007 End stop
- 6349 Curtain tape
- 6363 Iron tape
- 6391 Hanger
- 6392 Heading film
- 6393 Glider
- 6395 Extension
- 6398 Clip
- 6399 Carrier for draw rod



6140M

Fitting Information

Bracket positioning when using adjustable brackets 0537



Fitting of track to bracket

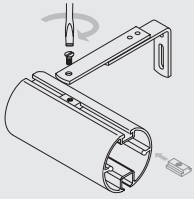

Using adjustable bracket 0537.

Fitting Options

Wall fix with adjustable brackets 0537

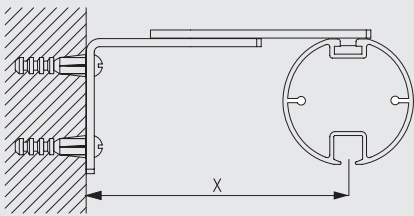

	X (mm)
0537	80-100

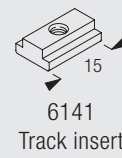
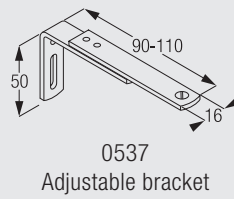

Wall fix with brackets 3134/2-3136/2

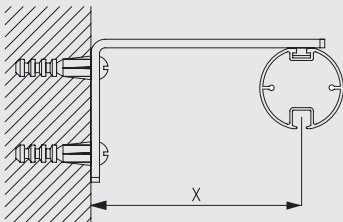

	X (mm)
3134/2	52
3135/2	72
3136/2	92

3134/b
Midial ceiling fix
bracket

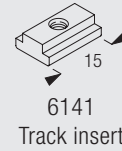

Wall fix with ultra brackets 6133 and 6134

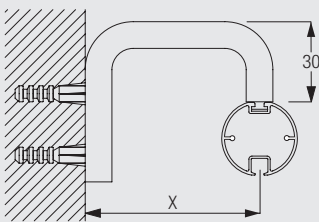

	X (mm)
6133	65
6134	115

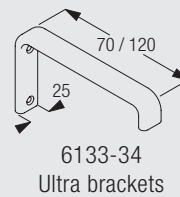

Wall fix with Vela bracket

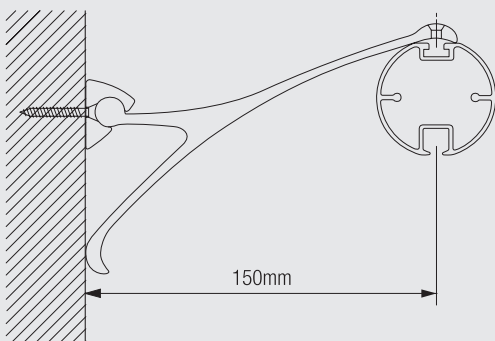

0731
Vela bracket

Ceiling fix with 6138P2

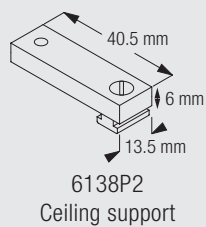
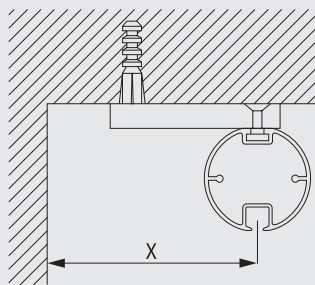









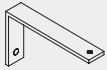





Min. distance from wall when using Wave XL: 220mm.

Standard Accessories

0537	Adjustable bracket		0700	Profile 50mm	
0714	End cap 50mm		3133	Bracket cover (60mm)	
6065	Twist eye endstop		6141	Track insert	
6143	Glider 6144 in strip form				

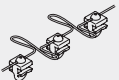
Optional Accessories

0713	Midial connecting bracket		0717	Ball end finial (50mm pole)	
0718	Spear finial (50mm pole)		0731	Vela bracket	
2216	Cord		2255	Adjustable brake	
3582	Hook		6007	Endstop	
6007	Endstop		6133	Ultra bracket (70mm)	
6134	Ultra bracket (120mm)		6283	Roller glider	
6345	Wave glider cord (60mm)		6346	Wave glider cord (80mm)	
6349	Wave curtain heading tape		6363	Top hemming tape	



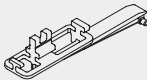

6140M

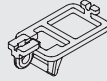
6364	Extension	
------	-----------	---

6366	Carrier for draw rod	
------	----------------------	---

6392	Heading film	
------	--------------	---

6394	Carrier	
------	---------	---

6398	Clip	
------	------	---

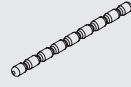
10075	Lead weight 50 gr/m	
-------	---------------------	---

3134/2	Pole extension bracket (60mm - all colours)	
--------	---	---

3136/2	Pole extension bracket (100mm - all colours)	
--------	--	---

6365	Hanger	
------	--------	---

6391	Hanger	
------	--------	---

6393	Glider	
------	--------	---

6395	Extension	
------	-----------	---

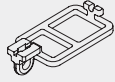
6399	Carrier for Draw rod	
------	----------------------	---

10076	Fabric weight	
-------	---------------	---

3135/2	Pole extension bracket (80mm - all colours)	
--------	---	---

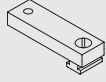
6138P2	Ceiling support	
--------	-----------------	---



6140M



6140M



6140M



6140M

www.silentgliss.co.uk

Silent Gliss Ltd
Pyramid Business Park
Poorhole Lane
Broadstairs
Kent
CT10 2PT
Great Britain

Tel: 0044 (0) 1843 863571
Fax: 0044 (0) 1843 864503
sales@silentgliss.co.uk